



The intelligent Schnierle safety belt reminder system



with radio transmission for up to 8 seats





The latest version of this instruction manual is available from the manufacturer or can be downloaded directly from our homepage using the QR code provided.

Before using your new DoubleCheck® safety belt reminder system for the first time, please read this manual carefully and observe the guidelines and notes.

We wish you much pleasure with your new DoubleCheck® safety belt reminder system and may you always have a good trip!

Your Schnierle team

Content

- 1. Guideline and introduction 3**
 - 1.1. Intended use 3
 - 1.2. Product specific data 3
 - 1.3. Introduction/ notes 3
 - 1.4. Use of the instruction manual 4
- 2. Putting into operation, control, service/maintenance and care 4**
 - 2.1. Installation/ putting into operation 5
 - 2.2. Checks 6
 - 2.3. Service and maintenance 7
 - 2.4. Care 7
- 3. Operating the DoubleCheck® safety belt reminder system 8**
 - 3.1. Seat occupancy display 8
 - 3.2. Function 8
 - 3.3. Pairing transmitter - receiver 8
 - 3.4. Trouble shooting 11
 - 3.5. Replacing the battery of the 12
- 4. Product information and dimensions 14**
 - 4.1. Product description 14
 - 4.2. Scope of application 14
 - 4.3. Dimensions 15
- 5. Notes on disposal 16**



1. Guideline and introduction

1.1. Intended use



Please read these following notes and safety information carefully and familiarise yourself with the different functions.

- The safety belt reminder system DoubleCheck® may only be used as a seat belt warning system, which indicates to the driver by means of a visual display and acoustic signal whether a seat is occupied and the seat belt is fastened.
- Any change to the series condition (e.g. by retrofitting of non-original retrofit and spare parts from Hermann Schnierle GmbH) may invalidate the tested condition of the system.

Functions could be impaired, endangering your safety.

For this reason, any modifications to the system must be approved by Hermann Schnierle GmbH.

- Installation, conversion, repair and retrofitting work on the system may only be carried out by authorised specialist workshops, trained or appropriately trained personnel or after approval by Hermann Schnierle GmbH, taking into account the applicable work instructions and country-specific regulations.
- Failure to comply with the descriptions contained in this instruction manual may result in a negative effect on your warranty. Hermann Schnierle GmbH does not accept any warranty or liability for resulting damage in the event of improper assembly, use and repair.
- When installing and removing the DoubleCheck® safety belt reminder system, it is essential to follow the vehicle manufacturer's instructions.

Caution

- Note: The safety belt reminder system DoubleCheck® may only be used in combination with Schnierle seating systems!
- The permitted operating temperature of the system is between -30°C and 80°C

1.2. Product specific data

- Please refer to your order and the delivery note for the scope of delivery according to the variant you have selected and ordered, see also 4.2. ➡ page 10

1.3. Introduction/ notes

This instruction manual provides you with all information you need for safe and efficient use of your DoubleCheck® system.

You are obliged to comply with the applicable laws and regulations of the country in which you are located. These may differ from the information in this instruction manual.

The operating instructions of the vehicle and body manufacturers must also be observed and are also applicable.

- The latest version of this instruction manual is available from the manufacturer or can be downloaded directly from our homepage using the QR code provided.
- The instruction manual must be read in full before putting into operation.







- Always keep the instruction manual and the QR code provided within easy reach in case of need; they should be carried in the vehicle and be accessible to the driver at all times.
- If the seat with DoubleCheck® system is passed on to a third party, the instruction manual must be passed on too.
- We reserve the right to make changes due to further developments that serve technical progress and the resulting deviations.



1.4. Use of the instruction manual

- In this instruction manual all options and features available for this model are described. Some descriptions may not apply due to the model variant selected.
- The table of contents at the beginning of this instruction manual helps you to orientate yourself quickly.
- Directional indications such as left/ right or front/ rear always refer to the direction of travel.

• Danger, warning and caution

 Danger	 Warning	Caution
Texts marked with  Danger indicate a risk of serious injury. Failure to comply this warning may endanger life.	Texts marked with  Warning indicate risks of accident and injury. Failure to observe the descriptions may result in injury.	Texts marked with Caution indicate possible damage to your Schnierle product. Failure to follow the description may result in damage to the product.

• Symbols

	Warning – relevant to safety
	Page references (Means see page...)

2. Putting into operation, control, service/maintenance and care

- Regular inspections, maintenances and care are important and necessary for the operational and road safety as well as the value retention of your safety belt reminder system.
- When installing or removing the safety belt reminder system, it is essential to follow the vehicles manufacturer’s instructions.
- The safety belt reminder system should only be installed, maintained and repaired by specialist staff. Any country-specific regulations and installation instructions of the vehicle manufacturer must be taken into account. The country-specific installation regulations can be obtained from the body or vehicle manufacturer.
- Make sure that no liquids get into the interior of the vehicle, the safety belt reminder system is not waterproof and should therefore be protected from splash water.



2.1. Installation/ putting into operation

- Remove the packaging material (cardboard boxes, foils, etc.) completely before using the seat and dispose it properly.
- The installation may only be carried out by the Hermann Schnierle GmbH and trained/qualified personnel.

The receiver is connected to terminal 30 (continuous current) as well as terminal 15 (ignition) and fused with 1 A. GND/ground can be connected from the vehicle structure or terminal 31.

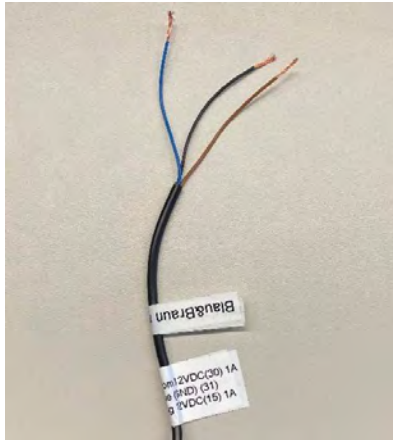

Blue: 9-16 VDC continuous current, **with 1A fuse.** (terminal 30)

Brown: 9-16 VDC ignition, **with 1A fuse** (terminal 15)

Black: Ground (terminal \downarrow 31)

- When retrofitting the DoubleCheck® safety belt reminder system, the additional working instructions for your seat model as well as the seat variant must be observed. Retrofitting may only be carried out by Hermann Schnierle GmbH and trained or qualified personnel.

It is recommended to use two fuse adapters when connecting the receiver in the vehicle. The fuse adapters serve once for the continuous current and once for the ignition.

The fuse adapter allows power to be supplied even if there is no empty slot available in the fuse box. The adapter replaces the selected fuse and enables the fused power supply of a consumer.

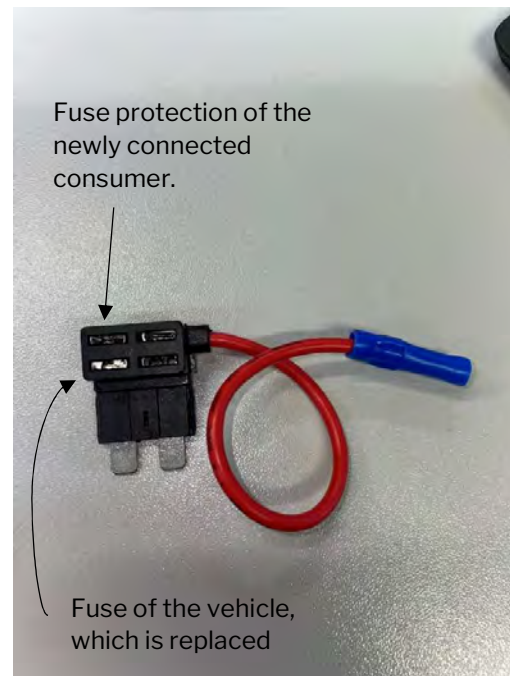



Caution

- It must be strictly noted to place the fuses in the correct slot on the fuse adapter. (see picture above)

The DoubleCheck® receiver is fused with 1A. The replaced fuse of the vehicle (in this case 10A) and the 1A fuse of your DoubleCheck® receiver must be placed as shown in the picture.

To disconnect the receiver from the DC supply, the two 1A fuses must be removed from the fuse adapter. It is recommended that the receiver fuses are operated, removed or replaced by qualified personnel.

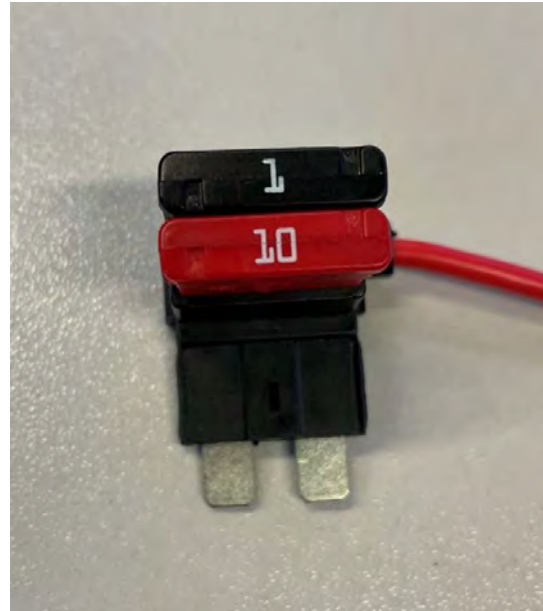

⚠ Warning

- Note the maximum permissible current of the fuse holder! (Usually fuse holders are designed for a maximum of 15A.)
 - The installation may only be carried out by a specialist. Only qualified personnel can prevent the vehicle's electronics from being affected or destroyed.
- After the installation of the receiver, make sure if the power supply to the affected components is as wished.
 - After completing the works, make sure that all electrical systems of the vehicle are still fully functioning. Therefore, the check list enclosed with the order must be checked.

2.2. Checks

⚠ Warning

- Regularly check the safety belt reminder system (Recommended: Before each journey).
- Check the safety belt reminder system for full functionality. The occupied seats should light up red and an acoustic warning signal should sound before buckling up.



2.3. Service and maintenance

- After an operating time of max. 3 years, the battery in the transmitter must be replaced. A low battery condition is indicated by the display flashing 3 times when the vehicle's ignition is switched on. In this case, the transmitter battery must also be replaced.
- In general, maintenance of the DoubleCheck® system should be carried out with the regular vehicle maintenance, unless otherwise described. However, after one year at the latest.
- If defects are found during the inspections (e.g. screw connections loose, parts damaged, cable break/kink...), these must be repaired immediately and exclusively by competent persons (e.g. authorised workshop of the vehicle manufacturer).
- After an accident, the safety belt reminder system must be checked and replaced if necessary.
- Modification or retrofitting work on the safety belt reminder system may only be carried out by authorised specialist workshops, trained or appropriately trained personnel or after approval by Hermann Schnierle GmbH, taking into account the applicable operating instructions and country-specific regulations.
- Improper installation may result in injuries as well as material damage and the function of the safety belt reminder system can't be guaranteed.
- Improper removal of the receiver may cause damage.

2.4. Care

- General: Dirt can impair the functions of your DoubleCheck® safety belt reminder system, therefore keep it clean and avoid contaminations if possible!
- Wipe your DoubleCheck® safety belt reminder system with a wet cloth as needed and then wipe with a dry cloth.
- Avoid direct contact with water!



3. Operating the DoubleCheck® safety belt reminder system

3.1. Seat occupancy display

State					Display				Signal tone		Remark
Ignition on	Seat occupied	Buckled up	Unbuckled again	Seat no longer occupied							
					Off	Orange	Red	Green	On	Off	
											On for 3 seconds Function Check
											Signal tone On after 60 seconds for 60 seconds
											Signal tone On after 2 seconds for 60 seconds

3.2. Function

The safety belt reminder functions independently from the vehicle speed

- As a system check, all seat symbols light up red for approx. 3 seconds when the ignition is activated.
- Seat is occupied: symbol lights up red. After 60 seconds an additional acoustic warning signal turns on for 60 seconds.
- Seat is not occupied: symbol doesn't light up
- Seat is occupied and passenger is wearing a seat belt: symbol lights up green
- Seat is not occupied, and the belt tongue is inserted: symbol lights up orange
- If the seat is occupied and the seat belt is released during the journey, the seat symbol lights up after 2 seconds and an acoustic warning signal sound.

3.3. Pairing transmitter - receiver

For the pairing and setting functions of the system, actuations are carried out by certain push buttons. The buttons must be actuated with pairing tools (pins – diameter approx. 1mm – e.g. paper clip). Two of these coupling tools are necessary.



Note: Before each pairing of a transmitter with a receiver (except for the first pairing), a reset must be carried out. This is done by pressing buttons 2 and 3 on the transmitter at the same time (see picture description transmitter). The pairing mode on the transmitter is terminated by confirming the position on the receiver (see description of receiver) or ends automatically after five minutes.

Avoid leaving the transmitter in pairing mode for too long, as this will significantly reduce the battery life. The pairing mode on the transmitter can also be ended by resetting the transmitter (simultaneously pressing buttons 2 and 3 on the transmitter).

A paired transmitter retains the coupling to the receiver even after the battery has been replaced.

Receiver:

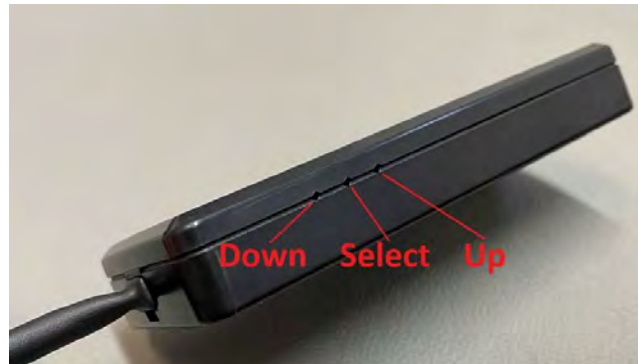

- **Double click Select:** The transmitter starts the pairing mode. In this mode, seats can be added or removed. The currently selected seat is indicated by red blinking. By Actuating the up and down button, the desired seat number can be selected. Special feature: If the seat number exceeds 8 or falls below 1, the coupling mode is automatically exited. This is also the case after 5 minutes if there is no activity.
- **Double click Select in pairing mode:** The pairing with the receiver is deleted for the currently selected seat number.
- **Up + Down:** By pressing the up and down button on the receiver simultaneously all connections with paired transmitters are deleted. All transmitters must then be paired again.



Transmitter:

The transmitter is put into operation by removing the battery contact insulation by simply pulling it out of the side of the housing.

To pair with the receiver the sticker on top of the device must be pierced at the areas marked as circles (pos. 1-3) with an object with max. diameter of 1mm and a min. length of 10mm. (e.g. paper clip).

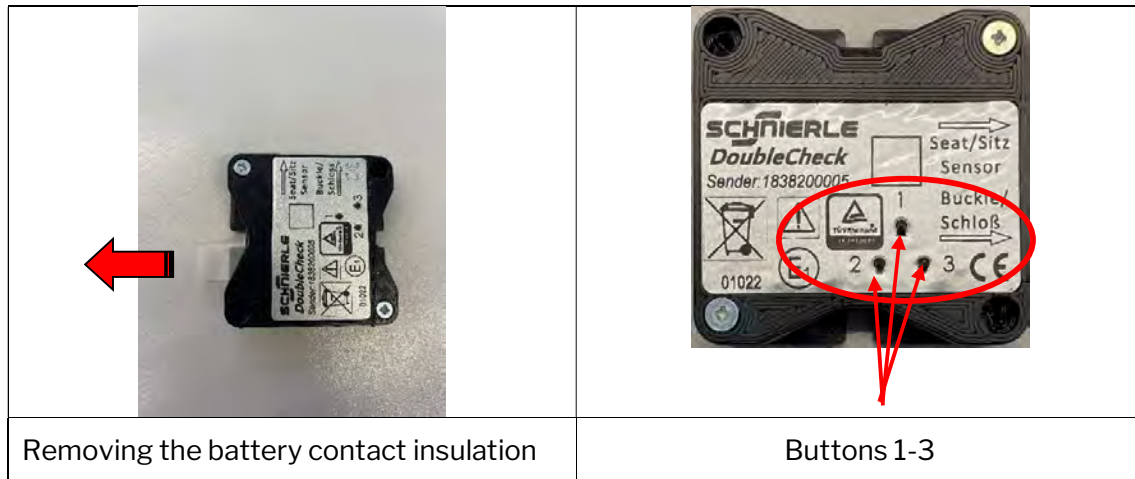

- **Double click button 1:** Pairing mode is activated on the transmitter. The transmitter now automatically pairs with a nearby receiver. The selection of the seat number is described above. As soon as the pairing has succeeded, the corresponding position on the receiver lights up yellow. The connected position (flashing yellow) must then be confirmed by pressing select on the receiver, thus saving the pairing. After successful pairing, the receiver will automatically switch to the next free position and light up red.

If the transmitter and receiver don't pair successfully, the transmitter is reset and the pairing process is restarted.

Note: Pairing can only take place when the receiver and transmitter are in pairing mode.

- **Pressing button 2 and 3 simultaneously:** The transmitter is deleted at the receiver and must be paired again.

Attention: After setting up the system and pairing the transmitters with the receiver, each connected seat must be checked for proper functioning (see 3.2.) before driving off.

In case of malfunctions, repeat the procedure described above.

If malfunctions occur that cannot be eliminated by setting up the system again, consult an authorised specialist company.



3.4. Trouble shooting

In the event that the system does not function as intended, it is important to know the faults and identify the component that is not functioning properly.

Possible functional errors:

1. The receiver does not switch on when the ignition is operated: Check the fuses and the ground connection. If no fault can be found, the receiver must be sent to Hermann Schnierle GmbH for inspection. Please follow the installation instructions. These can be requested from Hermann Schnierle GmbH.
2. The transmitter does not recognise the seat occupancy and/or the buckling or cannot be paired:
Please check the battery. If the battery is empty, it must be replaced as described below. If it is okay and still charged, send the transmitter to Hermann Schnierle GmbH for inspection.
3. The transmitter can be paired but doesn't react to seat occupancy or seat belt buckling:
Please check the seat occupancy mat and/or the seat belt buckle. If both components are okay, send the transmitter to Hermann Schnierle GmbH for inspection.

The target states of the seat occupancy mat and the belt buckle are as follows:

- **Seat occupancy mat not occupied:** Circuit open
- **Seat occupancy mat occupied:** Circuit closed
- **Seat belt buckle not buckled:** Circuit closed
- **Seat belt buckle buckled:** Circuit open

Attention

- If it is necessary to remove the receiver, you must follow the Double Check® receiver removal instructions. The cable can only be removed using a tool. Forcibly removing the cable without a tool may cause damage to your Schnierle product and/or result in injury.

Extract from the instructions:

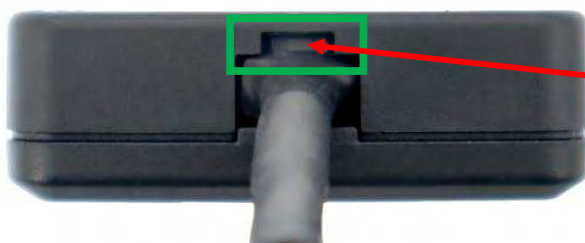

Insert a flat-head screwdriver between the **plug latch** and the **DoubleCheck® housing**, then lever the latch downwards by pushing the screwdriver upwards.

- Do not open the Double Check® receiver!



3.5. Replacing the battery of the

Before replacing the battery, take measures against electrostatic discharge. The following measures must be taken:

- In principle, electrostatic charging can be avoided by earthing. This grounding can be achieved by using a grounded ESD wrist strap.
- Wearing ESD-tested shoes also avoids electrostatic charging.
- Furthermore, the circuit board should not be touched directly. The transmitter should be touched and held by the housing.

After carrying out the above measures, the replacement of the battery can be started.

Attention

- A Jauch Quartz battery with the article number CR 2032 Jauch (IB) is required (due to the operating temperature limits).
- The battery can only be removed with the aid of tools (the housing is closed with screws). Forced opening without tools may cause damage to your Schnierle product and/or injury.

Danger

Do not ingest battery, risk of burns from hazardous substances!

This product contains a button cell battery. If the button cell is swallowed, severe internal burns can occur within just 2 hours and result in death.

Keep new and used batteries away from children.

If the battery compartment does not close securely, stop using the product and keep it away from children. The product must be replaced.

If you think that batteries have been swallowed or are in any part of the body, seek medical help immediately!

Step 1:

Loosen the two marked screws with a suitable screwdriver.





Step 2:

Open the housing of the transmitter. The halves can be pulled apart as they are not locked in place.

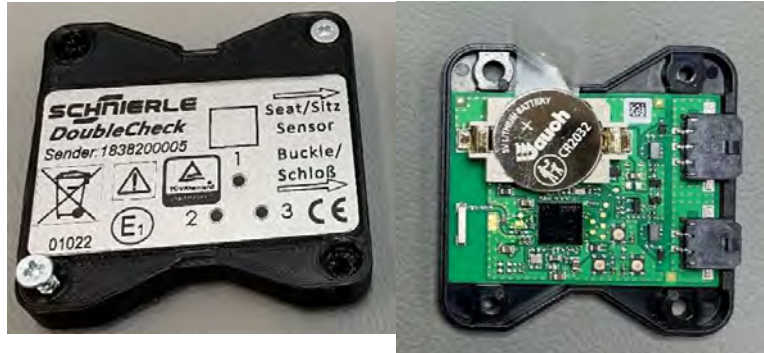

Step 3:

Remove the battery using a non-conductive tool.



Step 4:

Place the new battery in the socket provided for this purpose. The +-pole should point upwards.



Step 5:

Put the two halves of the housing together and screw the two screws together.





4. Product information and dimensions

4.1. Product description

DoubleCheck® is a wireless seat belt warning system that informs the driver by means of a visual display and acoustic signal whether a seat is occupied and the seat belt is fastened. The system consists of a receiver and 1 to max. 8 transmitters. The receiver is connected directly to the on-board power supply (continuous current battery and ignition) of the vehicle and is located in the driver's field of vision (similar to a navigation system). The transmitters are installed on the seats and connected to the seat belt buckle and the seat occupancy mat.

The basic requirement for operating or using this system is that the seat is equipped with an electric seatbelt buckle and a seat mat for occupancy detection. Hermann Schnierle GmbH or one of your partners will tell you whether it is possible to retrofit your seat.



Approved according to ECE-R10



Please observe the instructions for disposal. (see 5.)



This product has been certified by TÜV Rheinland



Please observe the battery warnings (see 3.5.)



This product meets all EU-wide requirements for safety, health and environmental protection.

4.2. Scope of application

Safety belt reminder system for the passenger compartment of minibuses and vans.



4.3. Dimensions

Dimensions Receiver



Dimensions Transmitter

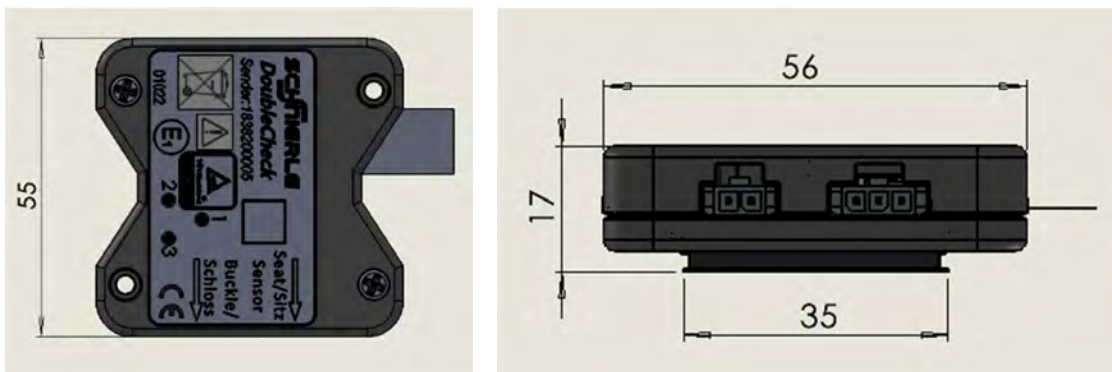



Dimensions seat occupancy mat

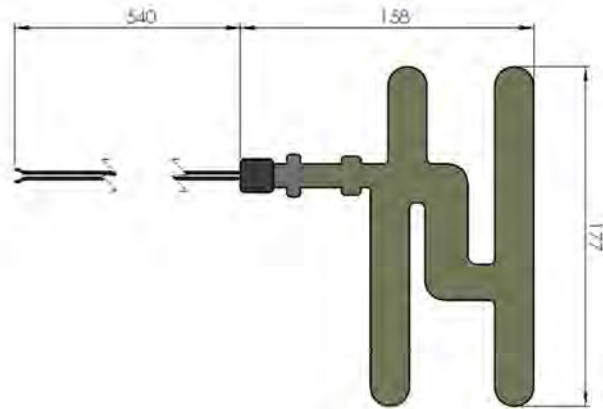

5. Notes on disposal



We would like to point out that electrical and electronic equipment as well as batteries must not be disposed of with household waste but must be collected separately.

The button cell must be disposed of separately from the electronics.

Imprint:

Hermann Schnierle GmbH
Dieselstr. 43
86368 Gersthofen
Tel: [+49 821 299 930](tel:+49821299930)
E-Mail: info@schnierle.de
www.schnierle.de

Managing director: Martin Schnierle, HRB Augsburg 7256

The information contained in this publication corresponds to the status stated below. Hermann Schnierle GmbH reserves the right to make changes to the technology, equipment and form of our products compared to the information in this publication as well as changes to this publication itself.